

1025 15 St, Canmore, AB

Main Building: Total Exterior Area Above Grade 2595.15 sq ft



Main Floor
Exterior Area 1446.86 sq ft



Upper
Exterior Area 1148.30 sq ft

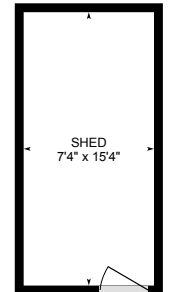

Shed
Exterior Area

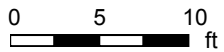

PREPARED: 2022/08/07

1025 15 St, Canmore, AB

Main Floor Exterior Area 1446.86 sq ft
Interior Area 1321.66 sq ft

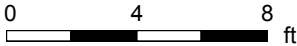

PREPARED: 2022/08/07



White regions are excluded from total floor area in iGUIDE floor plans. All room dimensions and floor areas must be considered approximate and are subject to independent verification.



1025 15 St, Canmore, AB

Upper Exterior Area 1148.30 sq ft
Interior Area 1039.21 sq ft
Excluded Area 73.26 sq ft



0 4 8 ft

PREPARED: 2022/08/07



White regions are excluded from total floor area in iGUIDE floor plans. All room dimensions and floor areas must be considered approximate and are subject to independent verification.

1025 15 St, Canmore, AB

Shed Excluded Area 135.76 sq ft

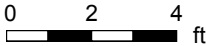
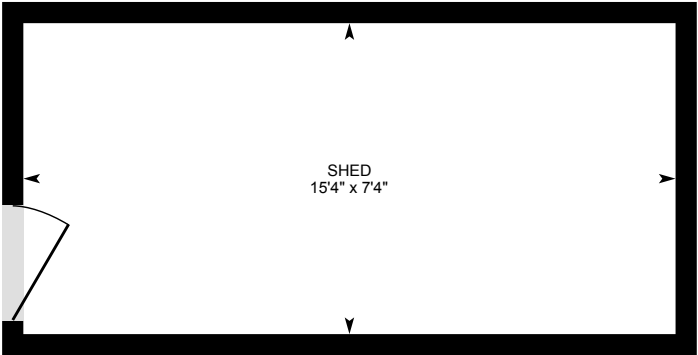

PREPARED: 2022/08/07



1025 15 St, Canmore, AB

Property Details

Room Measurements

Only major rooms are listed. Some listed rooms may be excluded from total interior floor area (e.g. garage). Room dimensions are largest length and width; parts of room may be smaller. Room area is not always equal to product of length and width.

Main Building

MAIN FLOOR

4pc Bath: 10'9" x 8'7"
4pc Ensuite: 9'11" x 6'1"
Bedroom: 15'4" x 15'7"
Bedroom/family: 10'9" x 14'10"
Laundry: 9'11" x 5'10"
Primary: 15'3" x 18'
Utility: 4'7" x 2'7"

UPPER

3pc Bath: 6'7" x 7'6"
Bedroom: 19'2" x 9'10"
Dining: 13'6" x 12'6"
Family: 19'1" x 20'11"
Kitchen: 12'7" x 14'4"
Office: 6'7" x 5'9"

SHED

Shed: 7'4" x 15'4"

Floor Area Information

Floor areas include footprint area of interior walls. All displayed floor areas are rounded to two decimal places. Total area is computed before rounding and may not equal to sum of displayed floor areas.

Main Building

MAIN FLOOR

Interior Area: 1321.66 sq ft
Perimeter Wall Thickness: 9.0 in
Exterior Area: 1446.86 sq ft

UPPER

Interior Area: 1039.21 sq ft
Excluded Area: 73.26 sq ft
Perimeter Wall Thickness: 9.0 in
Exterior Area: 1148.30 sq ft

SHED

All space is excluded

Total Above Grade Floor Area, Main Building

Interior Area: 2360.87 sq ft
Excluded Area: 209.02 sq ft
Exterior Area: 2595.15 sq ft

1025 15 St, Canmore, AB

Property Details

Customer Name: Brad Hawker and Drew Betts

Customer Company: Royal LePage Solutions

Prepared: Aug 7, 2022

August 7, 2022

Drew Betts and Brad Hawker

Royal LePage Solutions

1025 15 St, Canmore, AB

iGUIDE Method of Measurement

Definitions

Interior Area is a per floor calculation, made by measuring to the inside surface of the exterior walls. The footprint of all interior walls and staircases is typically included.

Excluded Area is a sum of the area of all rooms (measured to the inside surface of room walls) that are excluded from the Interior Area for a floor and the footprint of corresponding walls. Prescribed area exclusions can vary from region to region. Examples of exclusions are spaces open to below, garages, cold cellars, crawl and reduced height spaces.

Exterior Wall Footprint is the sum of the estimated area of the perimeter wall segments bounding both Interior and Excluded Areas.

Exterior Area is a per floor calculation, made by measuring to the outside surface of the exterior walls and is represented by the sum of the Interior Area and the Exterior Wall Footprint.

Grade is the ground level at the perimeter of the exterior finished surface of a house. A floor is considered to be above grade if its floor level is everywhere above grade.

Total Interior Area is the sum of all Interior Areas.

Total Excluded Area is the sum of all Excluded Areas.

Total Exterior Area is the sum of all Exterior Areas.

Finished Area is a per floor calculation made by adding all enclosed areas in a house that are suitable for year-round use based upon their location, embodying walls, floors, and ceilings and which are similar to the rest of the house. Footprint of walls is attributed to finished area only when the walls are bounding finished areas.

Unfinished Area is a per floor calculation made by adding all enclosed areas that do not meet the criteria for Finished Area. Exceptions are outdoor and non-walkable areas, for example porches or areas open to below. Footprint of walls is attributed to unfinished area only when the walls are exclusively bounding unfinished areas.

Notes

For exterior walls that are adjacent to the outside of the property, where typically only the interior side has measurement data, an estimation of the exterior wall thickness (as directly measured at the property) is used to calculate its footprint. Considerations are not made for varying wall thickness along the perimeter.

Disclaimer

All dimensions and floor areas must be considered approximate and are subject to independent verification.

PDF Floor Plans

A. RECA RMS 2017: Color is used to indicate all included areas. Excluded and not reported areas are shown in white. Walls are always shown in black.

B. ANSI Z765 2021: Color is used to indicate all finished areas. Unfinished and not reported areas are shown in white. Walls are always shown in black.

More Information About the Standards

A. RECA RMS 2017: <https://www.reca.ca/licensees-learners/tools-resources/residential-measurement-standard>

B. ANSI Z765 2021: <https://www.homeinnovation.com/z765>

1025 15 St, Canmore, AB

Measurement Diagram for: Main Floor
Exterior Wall Thickness: 9.0 in

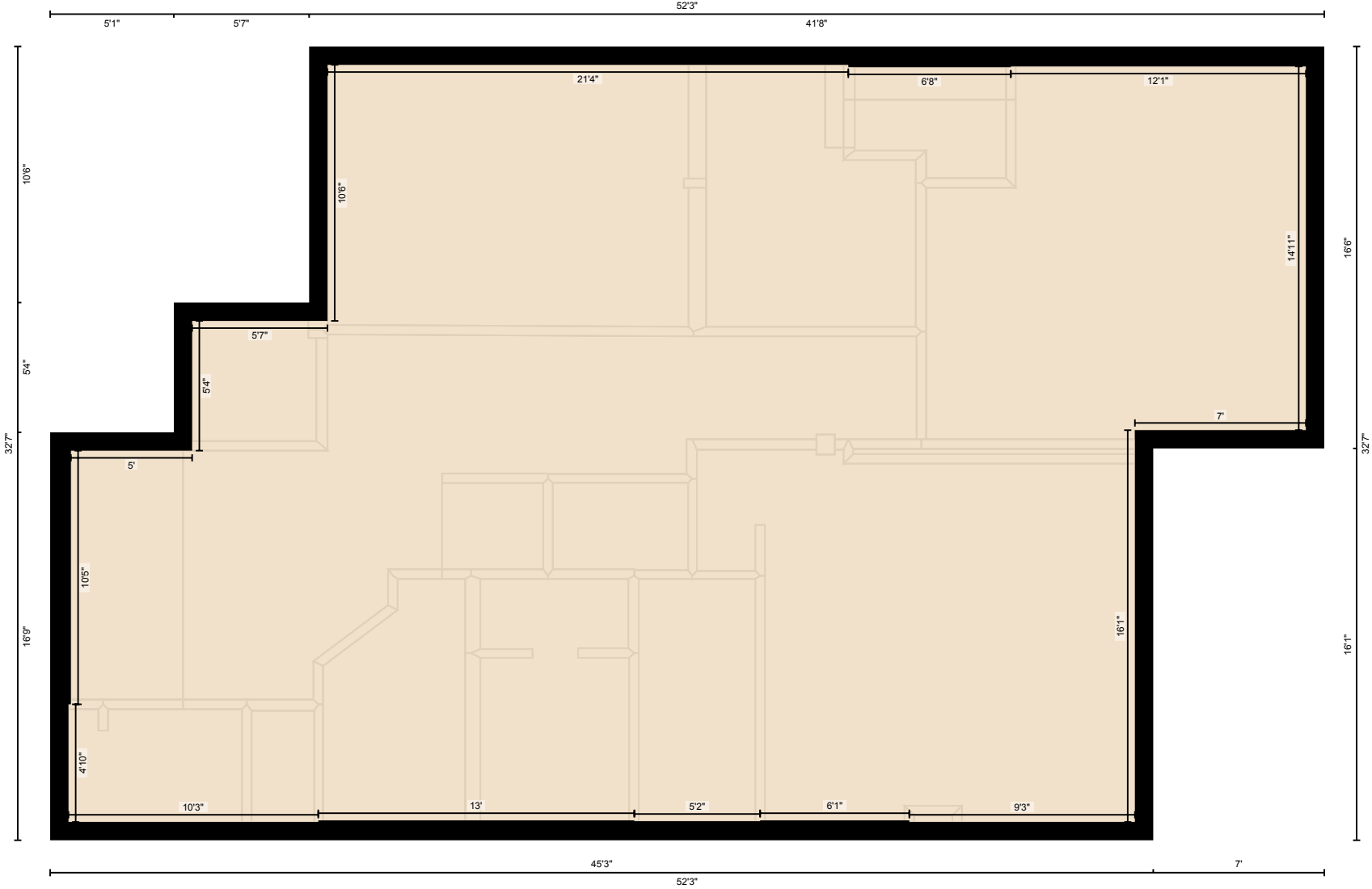

PREPARED: 2022/08/07

White regions are excluded from total floor area in iGUIDE floor plans. All room dimensions and floor areas must be considered approximate and are subject to independent verification.

1025 15 St, Canmore, AB

Measurement Diagram for: Upper
Exterior Wall Thickness: 9.0 in

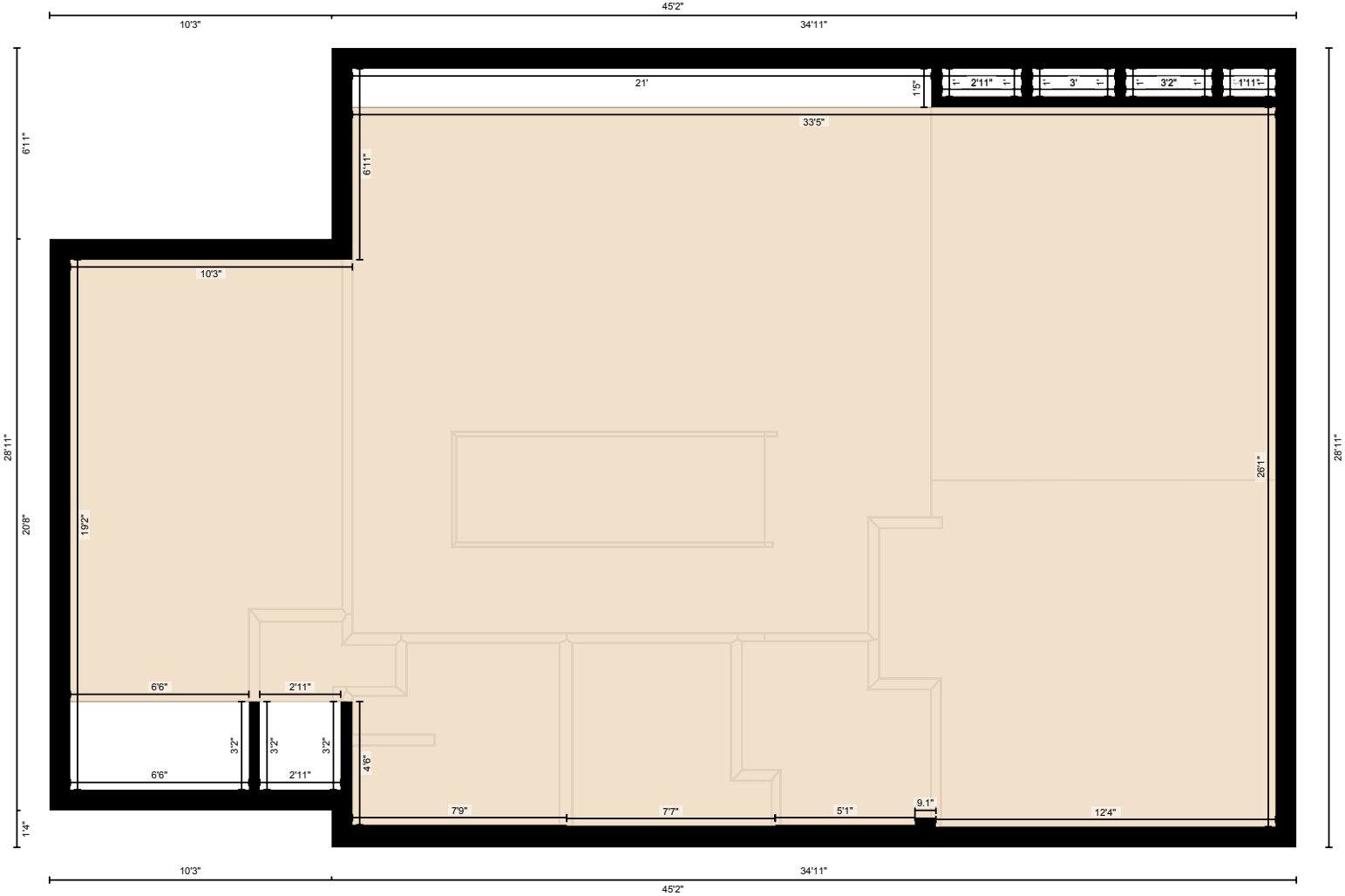

PREPARED: 2022/08/07

White regions are excluded from total floor area in iGUIDE floor plans. All room dimensions and floor areas must be considered approximate and are subject to independent verification.

1025 15 St, Canmore, AB

Measurement Diagram for: Shed
Exterior Wall Thickness: 6.0 in

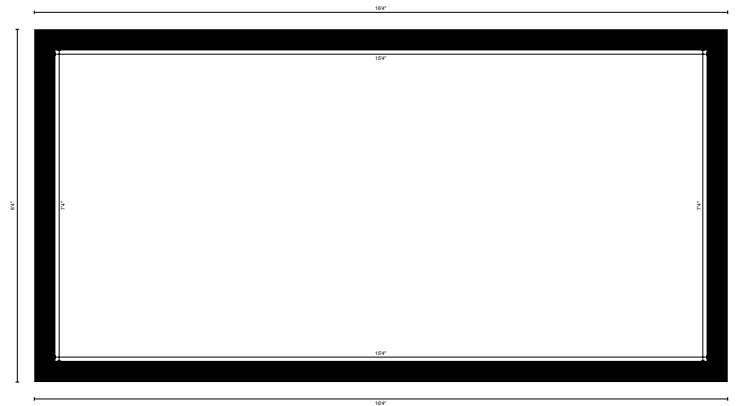

PREPARED: 2022/08/07